



“HAND  
ME THE  
MOUNTZ!”

## Mountz e-DRIV<sup>®</sup> EPT-Series DC Torque Transducerized Smart Cordless Screwdrivers Control System

# SAFEGUARDING AGAINST FASTENING FAILURES

- Error-proof the fastening process
- Programmable fastening sequences and workflows
- Data collection—record and store torque and fastening data
- Single cordless fastening system replaces up to 15 power tools
- Achieve multiple fastening tasks with one battery-operated screwdriver system
- Digital I/O allows interfacing with a machine & PLC interface for line control
- Transducerized Tool—traceability, superior accuracy and precision
- Free product software—no annual licensing required—savings of \$2K
- Clean room compliant (ISO14644-1 2015 Class 5)



# ACCELERATE SMART MANUFACTURING

Relied on by leaders in aviation, automotive,  
transportation, medical and electronic-all industries  
in which error-proofing process control is critical.





## **The all-in-one system that delivers productivity and quality advantages in complex manufacturing environments**

Mountz's all-in-one DC transducerized smart cordless screwdriver system safeguards against fastening failures for quality-minded engineers with critical industrial manufacturing applications requiring documented precision and accuracy torque control. The EPT-Series are available only through Mountz Torque, a battery-operated torque and automation control system engineered for precise, accurate and repeatable torque control. The lightweight, portable torque fastening system allows manufacturers to optimize the assembly area, reduce labor costs and increase productivity.

The screwdriver system can implement multiple fastening strategies for sensitive and difficult assembly joints. The system increases productivity as one tool can be programmed to do the job of numerous conventional tools, saving time, maintenance cost, space, and training.

## **Error-proofing manufacturing increases assurance in critical assembly operations**

The error-proofing system eliminates manufacturing risks and prevents product defects. Easily program the cordless screwdriver with fastening workflows and torque tolerances for each fastener in the sequence. The battery screwdriver provides error-proofing capabilities that track each screw the tools fasten. Program the tool not to clear an assembly until the completion of all the fastening events. When a fastening error occurs, the torque control system will detect it, flag it, and prevent the product from moving further down the line. The Industry 4.0 error-proofing tool has I/O interfaces that enable manufacturing integration for line control monitoring techniques. The IoT connected automation tool improves production and quality by collecting and storing data and providing real-time transparency in a manufacturer's assembly operations. Such real-time transparency enables quality assurance personnel to detect any fastening issues as soon as they arise.



## Easier process control and compliance

Assembly designs are getting more and more complex, while production speeds continue to increase. To compete, lean manufacturers strive to complete more work with fewer tools. A single Mountz cordless DC control system replaces up to 15 power tools. The battery-operated tool eliminates power cables in the work area and improves safety and operations by optimizing a company's manufacturing footprint. Achieve multiple fastening tasks with one cordless system. The assembly tool gives you the flexibility you need to carry out varied and complicated manufacturing plans. The transducerized tool features a built-in sensor that constantly measures torque and feeds data back into the system. Combined with built-in screw counters and error-proofing software, Mountz intelligent screwdriver system offers maximum production results and product oversight. And by providing documented fastening results, Mountz DC control tools also make regulatory compliance effortless.

## Fastening automation workflows

When there is a repetitive series of tightening tasks, manufacturers should implement a fastening automation workflow process. Often these repetitive tasks are managed across multiple workstations, tools, and assembly operators. By creating a fastening automation workflow, the manufacturing process becomes streamlined and reduces human error risk.

Group similar processes and assign a set of standardized tasks: program fastening sequences and torque tolerances for each fastener in a sequence for sensitive and complex assembly joints. Workflow automation is the best method to achieve tightening tasks efficiently. It produces reliable and accurate torque control results every time.

Workflow automation provides visibility of the various fastening tasks and improves production efficiency, consistency, and quality. The smart screwdriver system offers benefits for improving consistency and quality.

## Preset parameter settings

The EPT is operational as a standalone cordless screwdriver that allows you to program torque and fastening settings on the tool's display. The EPC-10 controller provides you the ability to program fastening settings and advance functions like the Job Manager. Each preset setting has the following programmable parameters:

PRESET SETTINGS	PROGRAMMABLE PARAMETERS
Tightening Mode	Torque control + angle monitoring (TC/AM) Angle control + torque monitoring (AC/TM)
Torque	Target torque, min/max torque, snug torque, seating torque, torque compensation
Angle	Target angle, min/max angle, free speed angle
Speed	Target speed, Free speed, Ramp up speed
Time	Soft start time, torque rising time, torque holding time
Thread Tapping	Target torque, min/max thread torque, speed, angle start
Screw Counting	Cycle start signal, time limit, total screw count, count port signal type

## Sequence control

Mountz DC control tools are easy to program and can remember up to 30 process sequences with 20 program steps. The tool gives you the flexibility you need to carry out varied and complicated manufacturing plans.

PROGRAM SETTINGS ON THE CORDLESS SCREWDRIVERS

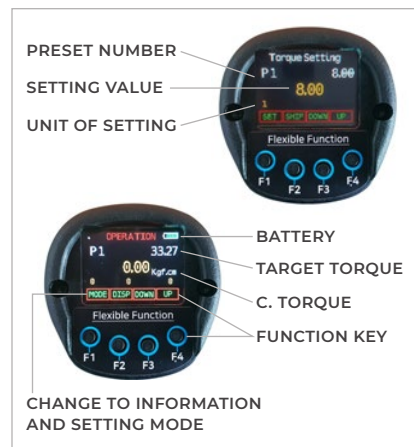

PROGRAM SETTINGS ON THE EPC-10 CONTROLLER

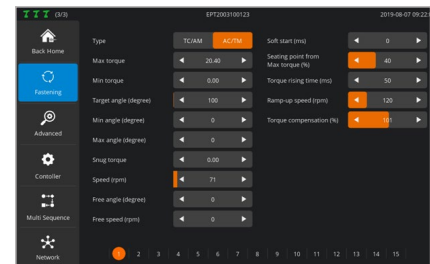

## Example with sample program of sequence control

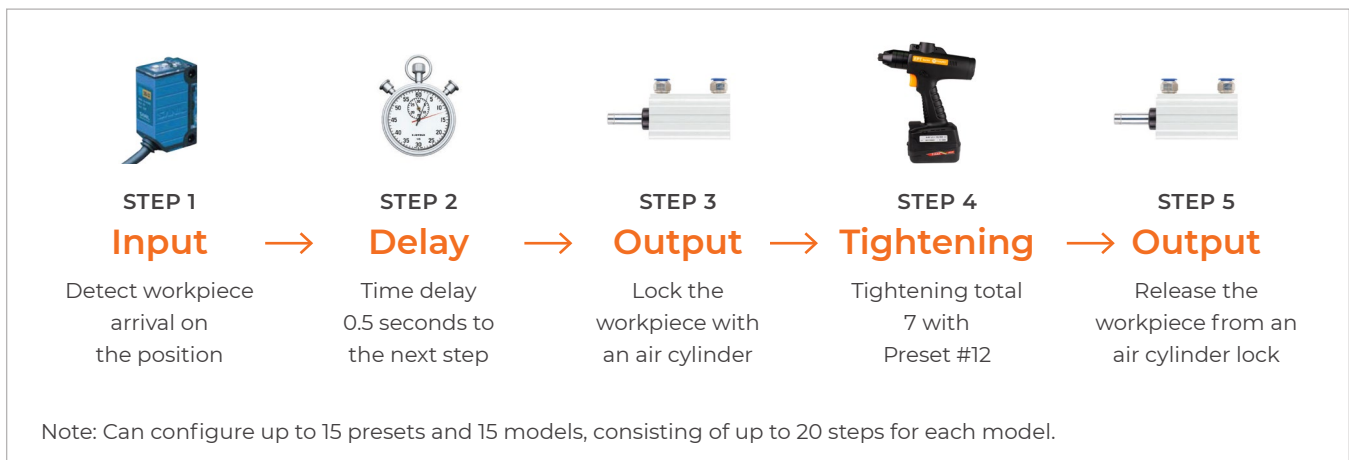

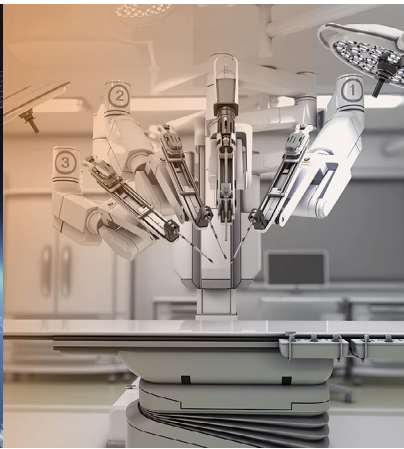

## Automation and production monitoring system

Assembly automation and line monitoring control systems are critical aspects of modern assembly line production. Manufacturing products with consistent quality requires automation equipment to execute production tasks with high precision and repeatability—the foundation of process control.

Automation techniques and equipment enable manufacturers to achieve and maintain process uniformity. A flexible automation system can assemble, process, monitor, and prevent fastening errors. Instead of tinkering with human process variables, a smart cordless screwdriver system is inherently well suited for automation process and effectively integrate with line control devices for a well-balanced production line.

## Enhance efficiency with built-in bar code scanner

The EPT cordless screwdriver features a built-in bar code scanner. Using the bar code scanner option allows the operator to instantly select and activate a programmed fastening event on the controller. A bar code scanner can scan the bar code to trigger the correct event and capture and record the data for each run down by assigning a bar code to a fastening event. This capability is an error-proofing technique that permanently links the fastening data with the right part. Combined with built-in error-proofing software, the cordless screwdriver offers maximum production results and product oversight. And by providing documented fastening results, these precision tools also make regulatory compliance effortless.

Error-proofing the assembly process by automatically verifying the scanned part against a predefined fastening process or real-time verification will provide substantial savings in rework, repair, and even recall costs.



BUILT-IN BAR CODE SCANNER

# PRODUCT OVERVIEW

FEATURE	WHAT IS IT?	ADVANTAGE	END USER BENEFIT
Data Collection	<ul style="list-style-type: none"> <li>Process of recording and storing the torque &amp; fastening data</li> </ul>	<ul style="list-style-type: none"> <li>Automate data collection</li> <li>Data centralization</li> <li>Uniform data</li> <li>Accurate real-time and historical information</li> </ul>	<ul style="list-style-type: none"> <li>Ensure conformity with quality standards &amp; regulatory compliances</li> <li>Accumulate fastening data efficiently into a database</li> <li>Capturing and analyzing data</li> <li>Document the assembly process</li> </ul>
Error-Proofing	<ul style="list-style-type: none"> <li>Mistake-proofing</li> <li>Implementation of fail-safe process and mechanism</li> </ul>	<ul style="list-style-type: none"> <li>Ensures correct torque is applied</li> <li>Eliminates risk in the process</li> <li>Prevent fastening failures</li> <li>Real-time monitoring and error detections</li> </ul>	<ul style="list-style-type: none"> <li>Prevent defects</li> <li>Reduce scrap rates</li> <li>Ensure high-quality standards</li> <li>Improve productivity &amp; quality</li> <li>Safeguards against fastening failures</li> </ul>
Screw Counting	<ul style="list-style-type: none"> <li>Count the number of screws delivered</li> <li>Detect and display fastening errors</li> </ul>	<ul style="list-style-type: none"> <li>Detects cross-threading, omissions, unfinished rundowns</li> </ul>	<ul style="list-style-type: none"> <li>Improve production efficiency</li> <li>Monitor the assembly process</li> </ul>
Process Control	<ul style="list-style-type: none"> <li>Program assembly sequences &amp; torque tolerances for each fastener</li> <li>Group similar processes and assign a set of standardized tasks</li> </ul>	<ul style="list-style-type: none"> <li>Create standardize fastening workflows</li> <li>Optimize the tightening process</li> <li>Streamline assembly workflow processes</li> </ul>	<ul style="list-style-type: none"> <li>Enhance process reliability &amp; efficiency</li> <li>Reduce processing time</li> <li>Improve consistency and quality</li> <li>Decrease downtime</li> </ul>
Productivity	<ul style="list-style-type: none"> <li>Achieve multiple fastening tasks with one tooling system</li> <li>Job Manager</li> </ul>	<ul style="list-style-type: none"> <li>A single cordless system replaces up to 15 tools</li> <li>Increase tooling efficiency</li> <li>Lean manufacturing</li> <li>Create visual assembly instructions</li> </ul>	<ul style="list-style-type: none"> <li>Increase production rate</li> <li>Reduce tooling costs</li> <li>Minimize the number of workstations</li> <li>Optimize workstation cycle time</li> <li>DC integrates with existing process control software</li> <li>Improve training process</li> </ul>
I/O Interface	<ul style="list-style-type: none"> <li>Enables integration for line control monitoring techniques</li> <li>4.0 MES system ready</li> </ul>	<ul style="list-style-type: none"> <li>Monitor fastening processes and tasks</li> <li>Industry 4.0 equipped automation tool</li> </ul>	<ul style="list-style-type: none"> <li>Real-time monitoring and notifications</li> <li>Digital signals for communication with external devices such as PLC</li> </ul>
Automation	<ul style="list-style-type: none"> <li>Industrial fastening automation</li> <li>Intelligent process automation</li> </ul>	<ul style="list-style-type: none"> <li>Replace manual processes</li> <li>Easy integration into a production line</li> <li>Reduce production costs and time</li> </ul>	<ul style="list-style-type: none"> <li>Maximize production capacity</li> <li>Lower production lead times &amp; bottlenecks.</li> <li>Flexible and agile to respond to demand shifts</li> </ul>
Torque Data Analysis	<ul style="list-style-type: none"> <li>Fastening torque data analysis</li> </ul>	<ul style="list-style-type: none"> <li>Performance metrics &amp; equipment effectiveness</li> <li>Data-driven manufacturing</li> <li>Standard Deviation, Mean, Average, CP, CPK analytics</li> </ul>	<ul style="list-style-type: none"> <li>Tool data management</li> <li>Predictive tool maintenance.</li> <li>Improve productivity and profitability</li> <li>Gain visibility into fastening process data</li> <li>Optimize manufacturing process</li> </ul>
Transducerized Tools	<ul style="list-style-type: none"> <li>Tool equipped with a transducer inside</li> </ul>	<ul style="list-style-type: none"> <li>Transducer is constantly measuring torque in real-time and feeding data back into the system.</li> <li>High degree of precision</li> </ul>	<ul style="list-style-type: none"> <li>Ensures fastening precision and accuracy</li> <li>Enhance the detection of fastening errors</li> <li>A documented and traceable torque tool</li> </ul>

## Mountz EPT-Series transducerized smart cordless screwdrivers



### PISTOL GRIP TRANSDUCERIZED MODELS

MODEL	ITEM NO.	TORQUE RANGES		ADJUSTABLE SPEED RPM	LENGTH	DRIVE SIZE	WEIGHT WITH BATTERY
		LBF.IN	N.M				
EPT50100-P	313131	8-39.8	0.9-4.5	100-1800	8 1/2"	1/4" F/Hex	3.8 lbs
EPT50104-P	313132	8-39.8	0.9-4.5	100-1800	8 1/2"	3/8" Sq. Dr.	3.8 lbs
EPT50120-P	313133	11.5-57.5	1.3-6.5	100-1250	8 1/2"	1/4" F/Hex	3.8 lbs
EPT50124-P	313134	11.5-57.5	1.3-6.5	100-1250	8 1/2"	3/8" Sq. Dr.	3.8 lbs
EPT50200-P	313135	20.4-101.8	2.3-11.5	50-690	8 1/2"	1/4" F/Hex	3.8 lbs
EPT50204-P	313136	20.4-101.8	2.3-11.5	50-690	8 1/2"	3/8" Sq. Dr.	3.8 lbs
EPT50300-P	313137	28.3-141.6	3.2-16	50-470	8 1/2"	1/4" F/Hex	3.8 lbs
EPT50304-P	313138	28.3-141.6	3.2-16	50-470	8 1/2"	3/8" Sq. Dr.	3.8 lbs
EPT50500-P	313139	42.5-212.4	4.8-24	50-310	8 1/2"	1/4" F/Hex	3.8 lbs
EPT50504-P	313140	42.5-212.4	4.8-24	50-310	8 1/2"	3/8" Sq. Dr.	3.8 lbs

Note: Each screwdriver includes two batteries. Charger sold separately.



### RIGHT ANGLE TRANSDUCERIZED MODELS

MODEL	ITEM NO.	TORQUE RANGES		ADJUSTABLE SPEED RPM	LENGTH	DRIVE SIZE	WEIGHT WITH BATTERY
		LBF.IN	N.M				
EPT50100-RA	313141	8-39.8	0.9-4.5	100-1800	19 1/3"	1/4" F/Hex	4.5 lbs
EPT50104-RA	313142	8-39.8	0.9-4.5	100-1800	19 1/3"	3/8" Sq. Dr.	4.5 lbs
EPT50120-RA	313143	11.5-57.5	1.3-6.5	100-1250	19 1/3"	1/4" F/Hex	4.5 lbs
EPT50124-RA	313144	11.5-57.5	1.3-6.5	100-1250	19 1/3"	3/8" Sq. Dr.	4.5 lbs
EPT50200-RA	313145	20.4-101.8	2.3-11.5	50-690	19 1/3"	1/4" F/Hex	4.5 lbs
EPT50204-RA	313146	20.4-101.8	2.3-11.5	50-690	19 1/3"	3/8" Sq. Dr.	4.5 lbs
EPT50300-RA	313147	28.3-141.6	3.2-16	50-470	19 1/3"	1/4" F/Hex	4.5 lbs
EPT50304-RA	313148	28.3-141.6	3.2-16	50-470	19 1/3"	3/8" Sq. Dr.	4.5 lbs
EPT50500-RA	313149	42.5-212.4	4.8-24	50-310	19 1/3"	1/4" F/Hex	4.5 lbs
EPT50504-RA	313150	42.5-212.4	4.8-24	50-310	19 1/3"	3/8" Sq. Dr.	4.5 lbs
EPT50604-RA	313151	56.7-283.2	6.4-32	50-200	19 1/3"	3/8" Sq. Dr.	4.5 lbs
EPT50804-RA	313152	70.8-354	8-40	50-160	19 1/3"	3/8" Sq. Dr.	4.5 lbs
EPT50805-RA	313153	70.8-354	8-40	50-160	19 1/3"	1/2" Sq. Dr.	4.5 lbs
EPT50904-RA	313154	88.5-442.5	10-50	50-115	19 1/3"	3/8" Sq. Dr.	4.5 lbs
EPT50905-RA	313155	88.5-442.5	10-50	50-115	19 1/3"	1/2" Sq. Dr.	4.5 lbs

Note: Each screwdriver includes two batteries. Charger sold separately.



## EPT-SERIES CORDLESS SCREWDRIVERS SPECIFICATIONS

Battery power	DC25.2V, 3A max
Motor	Swiss DC servo motor
WiFi	IEEE 802.11a/b/g/n 2.4GHz & 5GHz dual band
USB	Mini USB port
Display	1.29" AMOLED color display
Number of presets	15 presets

### Network connection options

Connection to a PC for setting and data back-up.

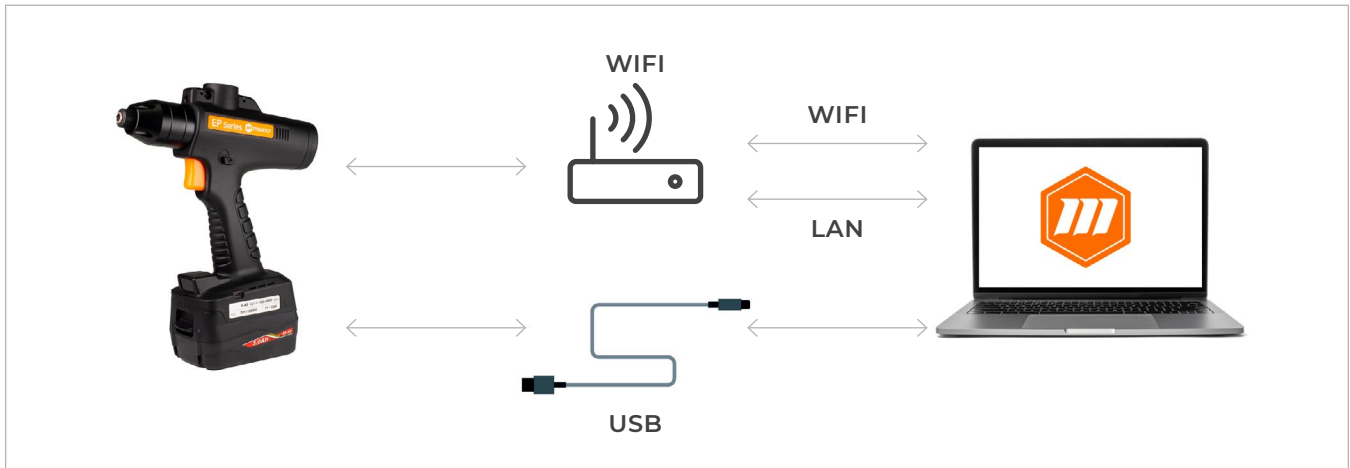

Connection to an EPC-10 controller and Paramon Pro X software.



## EPC-10 controller for EPT cordless screwdrivers

- Able to connect up to 8 EPT cordless screwdrivers
- Program or verify parameter settings for cordless screwdrivers
- Job Manager is a process control interface that makes it easy to create, save and recall visual assembly instructions for an operator to use.
- Fastening Quality Control: OK/NG monitoring of screw fastening by preset pattern of angle and/or time
- Display fastening data in real-time. Automatically saves and stores data
- Remote tool control
- Screw counting
- Front panel 10.1" Color LCD with touch screen
- 16 Input & 16 Output flexible I/O (25P D-Sub)
- Communication 1 x RS232C, 1 x Ethernet, WiFi
- Protocol: Modbus
- 4.0 MES system ready
- Mini SD Card data memory slot (memory card included)
- Mounting bracket included
- Supports barcode scanner
- Supports file transfer protocol (FTP) server



### EPC-10 Controller

Item # 313005

For EPT cordless screwdrivers

Note: Includes WiFi Adapter and Mini USB Cable

## EPC-10 SPECIFICATIONS

Input Power	AC 100-240 V, 50/60Hz, 0.35A
Dimensions	11 3/4" (W) x 7 3/4" (H) x 3 1/8" (D)
Weight	7.8 lbs. (Including wall mount bracket)
Mounting	VESA 100 x 100 (wall mount bracket included)
Display	10.1 touch screen (1280 x 800 px)
Extended Display	HDMI x 1 (duplicate)
Storage	On-board 8GB eMMC
Ethernet	Gigabit Ethernet x 1
WiFi	Wireless USB adapter included 2.4GHz, 5GHz dual-band, IEEE 802.11 b/g/n/ac AP-mode only
Interface	USB 2.0 x 3 24V digital I/O (input x 16, output x 16)= Micro-SD slot (up to 32GB)
Multi-Language	English, Spanish, French, German, Mandarin, Portuguese

## Modbus protocol communication

EPC-10 provide the Modbus RTU for RS232 and Modbus TCP/IP for the Ethernet port connection.

### MODBUS RTU

Slave ID	F Code	Data	CRC
----------	--------	------	-----

### MODBUS TCP/IP ADU

Transaction ID	Protocol ID	Length	Unit ID	F Code	Data	CRC
----------------	-------------	--------	---------	--------	------	-----

## Job Manager (Process control)

This error-proofing feature makes it easy to create, save and recall visual assembly instructions or training guides for an operator to use.

- Upload image and drawing files of a workpiece
- Program the fastening sequence
- Program up to 99 screws can per fastening step
- Adjustable color and radius settings for the circular guide indicators

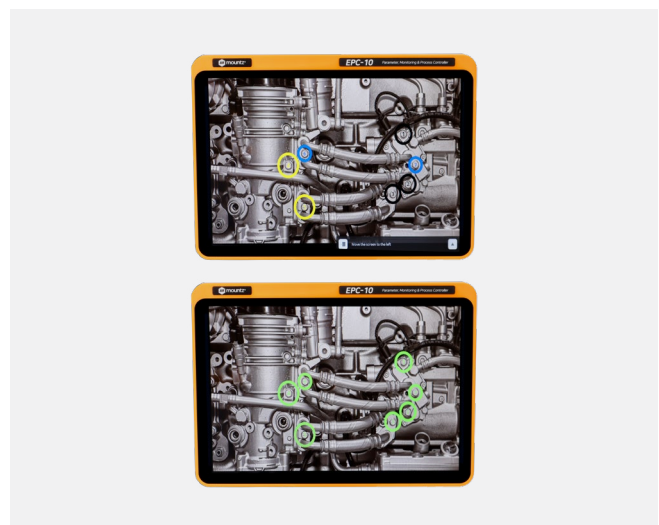

## Software

Program preset parameter, work instructions, monitor the fastening process. Collect and store essential quality data in a repository for data analytics, regulatory compliance, and traceability.

- Provides easy workflow and parameter settings, data monitoring & analysis
- Create, save and display visual assembly instructions and procedures
- 2 channel real-time curve display for torque, speed, angle.
- Torque capability analysis for mean value, standard deviation, CP, and CPK.
- Auto data output on every event in the Modbus protocol.
- Free product software and upgrade—no annual licensing required

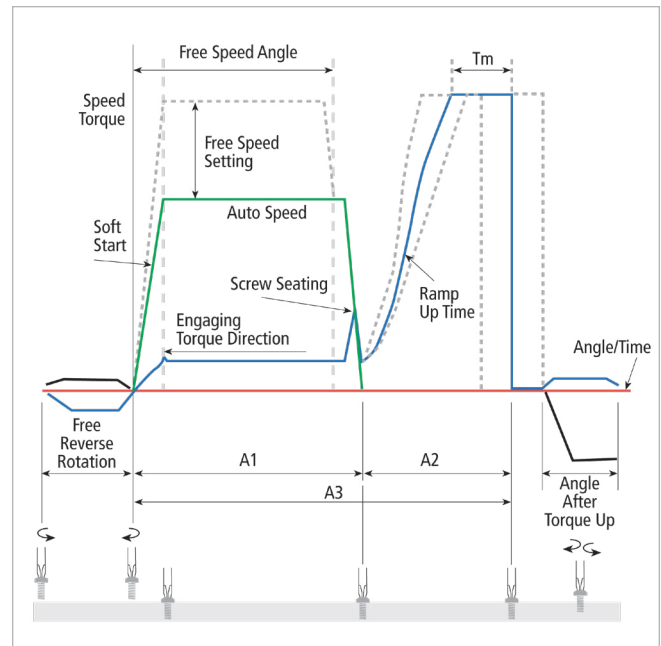

### PARAMON-PRO X SOFTWARE WITH EPC-10 CONTROLLER

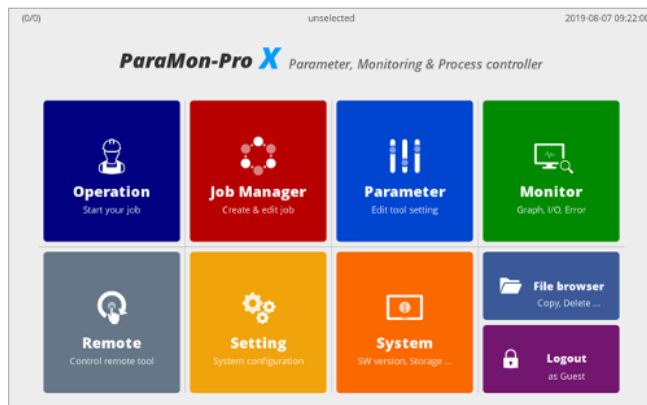

### TOOL MANAGEMENT—MONITOR UP TO 8 TOOLS

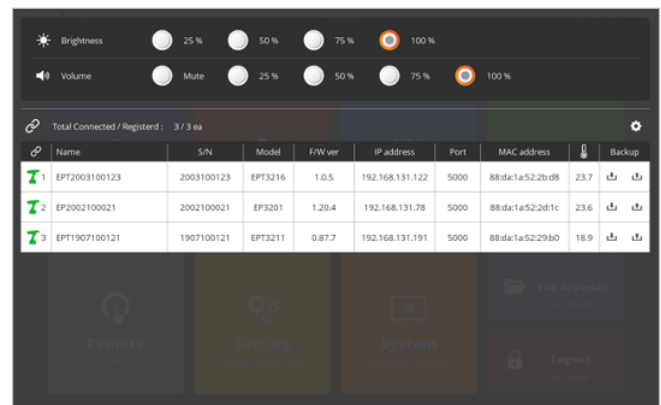

### REAL-TIME GRAPH MONITORING

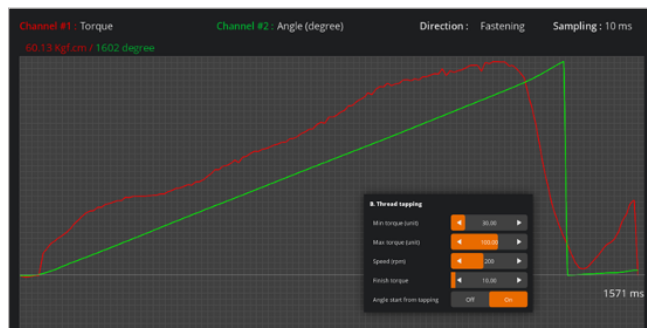

### FASTENING SEQUENCE

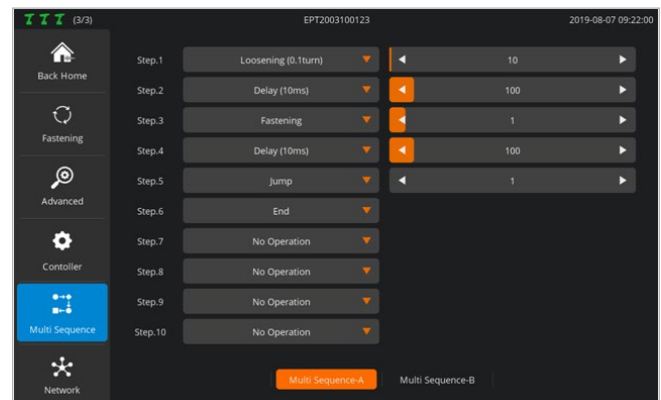



# ACCESSORIES

### Vertical Controller Stand

The vertical stand is an accessory option to mount the EPC-10 Controller for placement on an assembly workbench station.

**Vertical Controller Stand**  
Item # 310203



---

### Battery charger



**Charger for EPT Battery (110V, 60 Hz)**  
Item #313104

**Charger for EPT Battery (220-240V, 50/60 Hz)**  
Item #313103

### Battery



**EPT-Series Li-ion Battery (25.2V 3.0A)**  
Item #313102

---

### Pistol Grip Side Handle

The pistol grip side handle is an optional accessory that mounts on either side for additional handgrip, greater control, and versatility.

For use with only pistol grip models for EPT-Series cordless screwdrivers.

**Pistol Grip Side Handle**  
Item # 313199



## 44P I/O Wiring Box

It provides easy and convenient wiring for 12 inputs and outputs for a EPC-10 controller by sharing one single 24V power source (Input power: 24VDC 1A).

A I/O Cable is needed to connect to a controller.

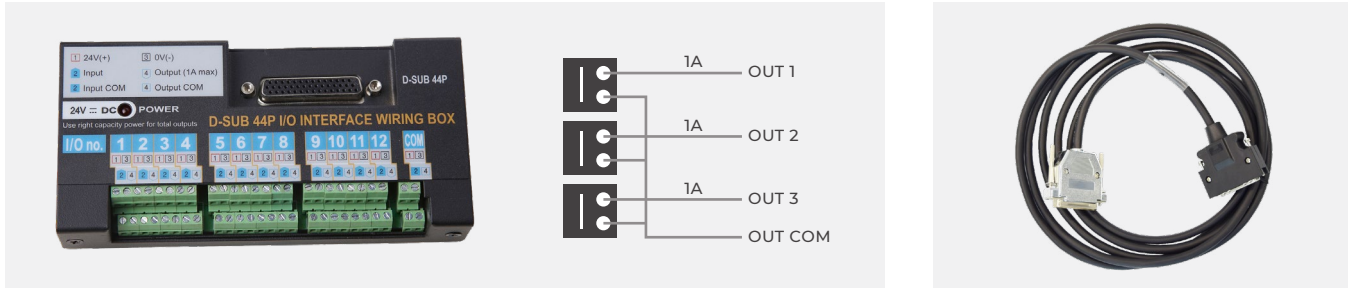

### I/O Wiring Box

Item #310055

Note: It requires an AC Adapter, Item #310102

### I/O Cable 3m

(44P male to 25P male)

Item #310057

D_SUB 44P									
1	In 1	10	In 10	19	Out 4	28	-	37	Out Com
2	In 2	11	In 11	20	Out 5	29	Out Com	38	-
3	In 3	12	In 12	21	Out 6	30	Out Com	39	-
4	In 4	13	-	22	Out 7	31	24V+	40	-
5	In 5	14	In Com	23	Out 8	32	24V+	41	-
6	In 6	15	In Com	24	Out 9	33	24V+	42	-
7	In 7	16	Out 1	25	Out 10	34	-	43	-
8	In 8	17	Out 2	26	Out 11	35	Out Com	44	-
9	In 9	18	Out 3	27	Out 12	36	Out Com		

## EPC-10 controller cables

Various supporting cables for the controllers.



**RS232 Cable**  
**(DB9 male x DB9 female, 2m)**  
Item #773856



**Cable**  
**(USB to RS232 adapter)**  
Item #773069



**I/O Cable 3m**  
**(44P male to 25P male)**  
Item #310057





Achieve a robust manufacturing process using Mountz intelligent cordless screwdriver system.

ENGINEERED IN SILICON VALLEY  
MOUNTZ  
SINCE 1965

#### ABOUT MOUNTZ

Mountz, The Torque Tool Specialists®, has been a leader in the torque tool industry for more than 55 years. Engineered in the Silicon Valley and serving the globe, Mountz focuses on delivering high-quality torque products, services, and solutions to ensure customers can always proceed with confidence. We are committed to forging a safer world through precision and accuracy, and by innovating every day.



[mountztorque.com](http://mountztorque.com)

#### SILICON VALLEY HEADQUARTERS AND SERVICE CENTER

1080 N. 11th St., San Jose, CA 95112  
408-292-2214 / M-F 6am-5pm PST

#### ALABAMA DISTRIBUTION AND SERVICE CENTER

19051 Underwood Road, Foley, AL 36535

#### INTERNATIONAL

For inquiries outside of the USA,  
Canada, and Mexico, please contact:  
[international@mountztorque.com](mailto:international@mountztorque.com)  
Phone: +44 1428 741756